



Parts Manual

Model _____ Fork Positioner _____

Serial Number _____ 35K-IFS-A100 R0 _____

cascade[®]
corporation

For Technical Assistance call: 800-227-2233, Fax: 888-329-8207

To Order Parts call: 888-227-2233, Fax: 888-329-0234

OR

Write: Cascade Corporation, P.O. Box 20187, Portland, OR 97220

Internet: www.cascorp.com

Fork Positioner Assembly

Sticker showing operating pressure,
phone numbers for service & parts.

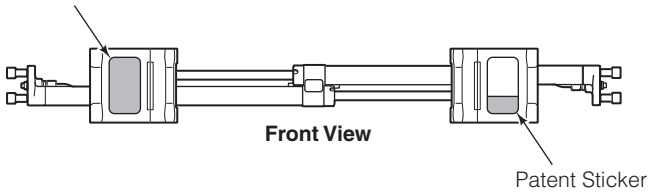

Assembly part number (on LH fork carrier).

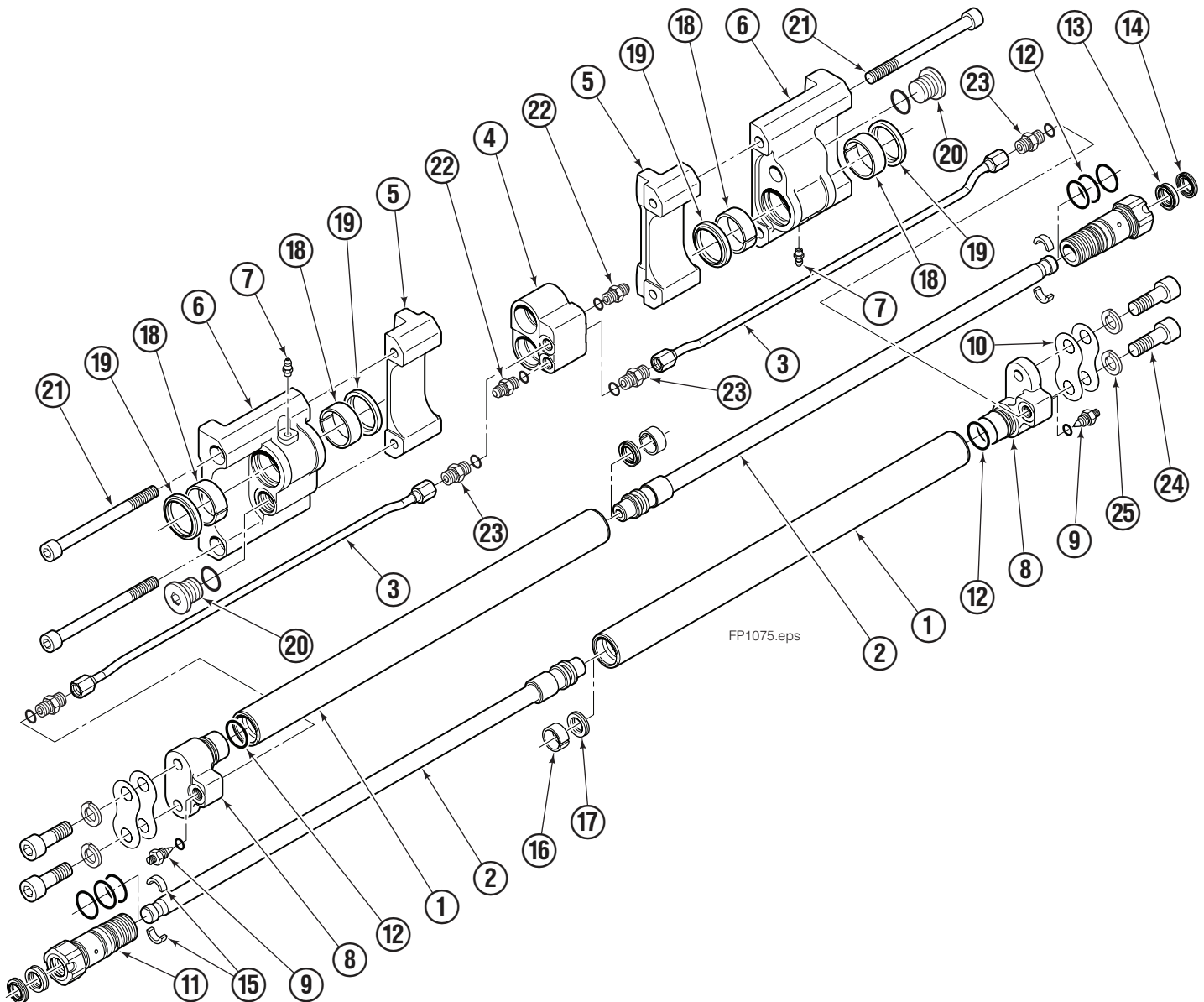

Fork Positioner Assembly

35K			
REF	QTY	PART NO.	DESCRIPTION
		6054521	Fork Positioner Assembly
1	2	6054522	Cylinder Shell ▲
2	2	6054523	Cylinder Rod ▲
3	2	6047381	Tube
4	1	6043391	Manifold
5	2	6042443	Fork Carrier, Inner, 80/100 mm Fork
6	2	6042449	Fork Carrier, Outer
7	2	424115	Grease Fitting
8	2	6052709	Cylinder Head End
9	2	6042658	Restrictor Fitting
10	4	6039245	Shim
11	2	6039028	Cylinder Retainer
	2	6055787	Cylinder Retainer w/Seals ◆
12	8	666183	O-Ring, Retainer OD ✘
13	2	6039179	Rod Seal, Retainer ✘
14	2	6039180	Rod Wiper, Retainer ✘
15	4	6042830	Half-Ring Keeper
16	2	6039172	Piston Wear Ring ✘
17	2	6047577	Piston Seal ✘
18	4	6039171	Bearing, Composite ★
19	4	6043341	Shell Wiper ★
20	2	6043316	Rod Retainer Plug
21	4	768824	Capscrew, M10 x 120
22	4	6042689	Fitting, M10 to 6 mm EO-2
23	2	6043332	Fitting, M10 to No.4 JIC ●
24	4	769572	Capscrew, M12 x 35 ■
25	4	684660	Lockwasher, M12 ■

▲ If cylinder shell or rod needs replacing due to bending damage, order complete Fork Positioner Assembly.

◆ Includes items 12-14.

✘ Included in Cylinder Service Kit 6055389.

★ Included in Composite Bearing Service Kit 6055390.

● Included in Fitting Group 6045440.

■ Included in Mounting Kit 6045442.

Reference: Common Parts 6045406, SK-8117.

Integral Sideshifter

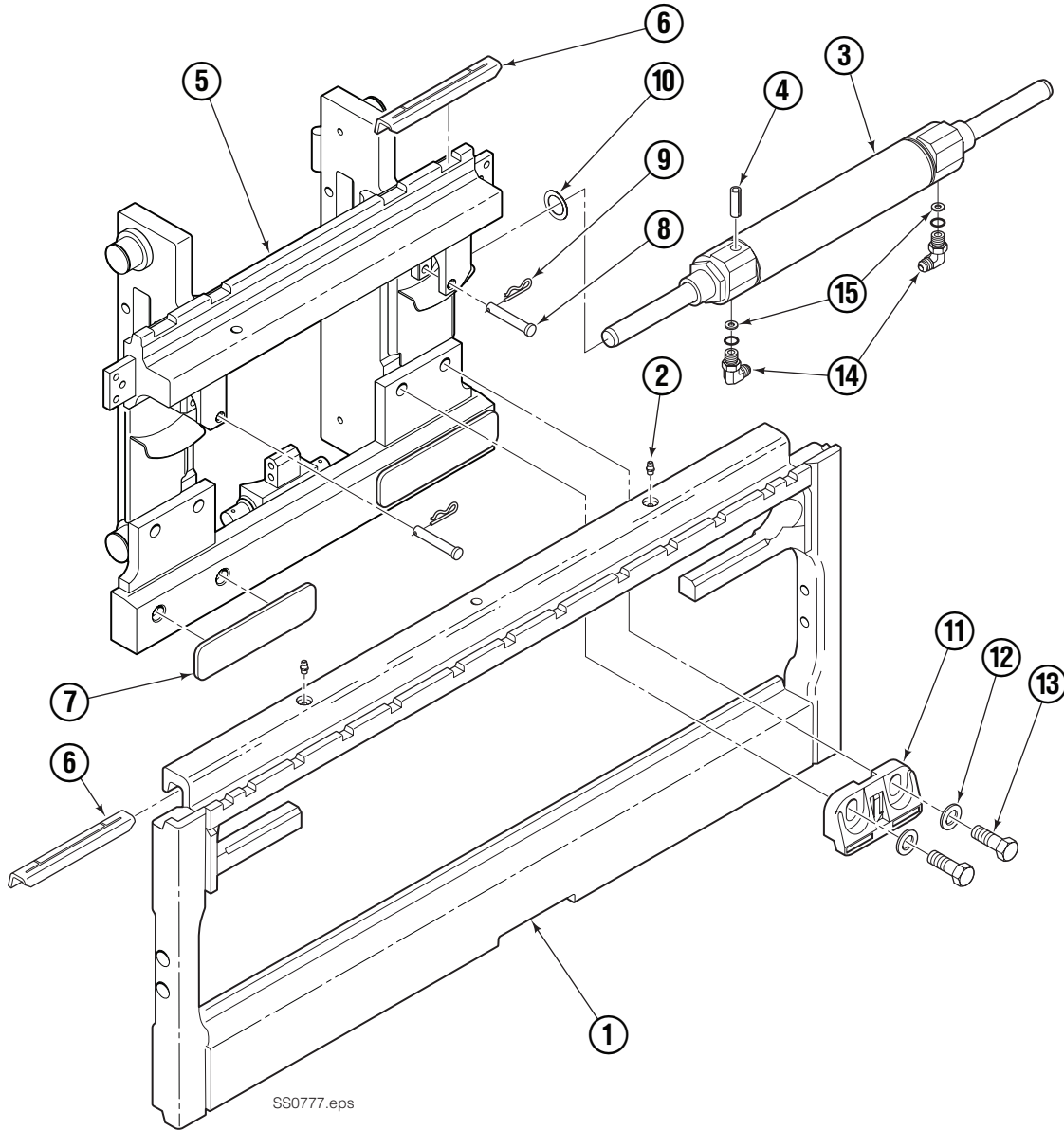

35K							
REF	QTY	PART NO.	DESCRIPTION	REF	QTY	PART NO.	DESCRIPTION
1	1	6073437	Outer Frame	9	2	6022929	Cotter Pin
2	2	651853	Grease Fitting	10	3	6016591	Shim
3	1	6020048	Cylinder ▲	11	2	8508373	● Lower Hook
4	1	769050	Roll Pin	12	4	667225	● Washer
5	1	6073438	Inner Carriage	13	4	684295	● Capscrew, M16 x 35
6	2	8508374	Upper Bearing	14	2	666984	Fitting, 4-6 ■
7	2	8508376	Lower Bearing	15	2	221733	Restrictor Washer ◆
8	2	6016592	Clevis Pin				

▲ See Cylinder page for parts breakdown.

● Included in Lower Hook Group 6018267.

Reference: Common Parts 6018712, S-23113, S-22874 Type 1.

■ Included in Fitting Group 205747.

◆ Included in Restrictor Washer Group 221732.

Cylinder Assembly

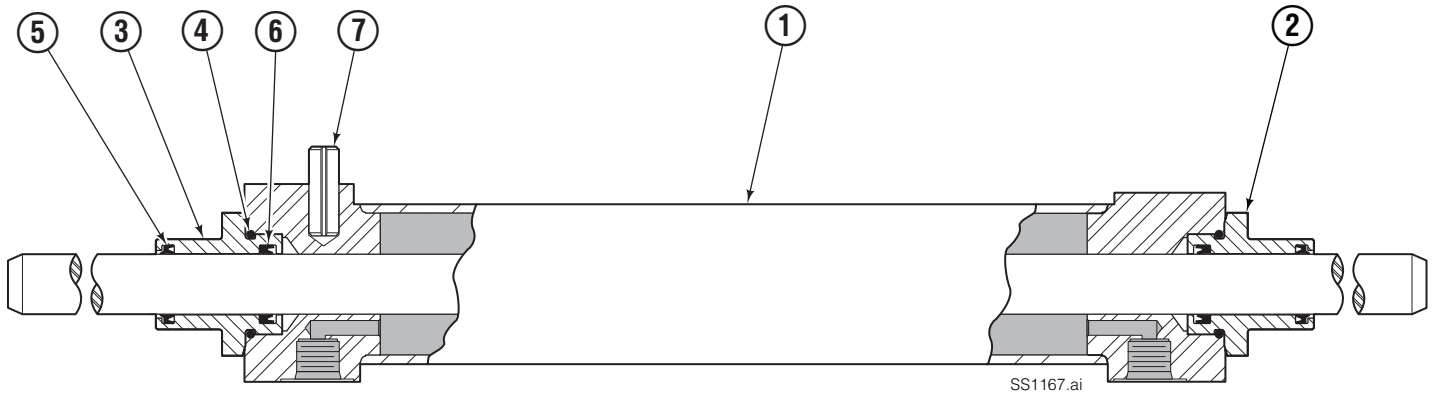

SS1167.ai

REF	QTY	PART NO.	DESCRIPTION
		6020048	Cylinder Assembly
1	1	◆	Cylinder Weldment
2	2	6017490	Retainer Assembly ●
3	1	6016571	Threaded Retainer
4	1	415866	O-Ring
5	1	562131	Seal Wiper
6	1	562132	Rod Seal
7	1	769050	Roll Pin

◆ Not serviceable.
Order complete cylinder if replacement needed.

● Includes items 3-6.

Reference: S-21145.

Installation Kit Toyota

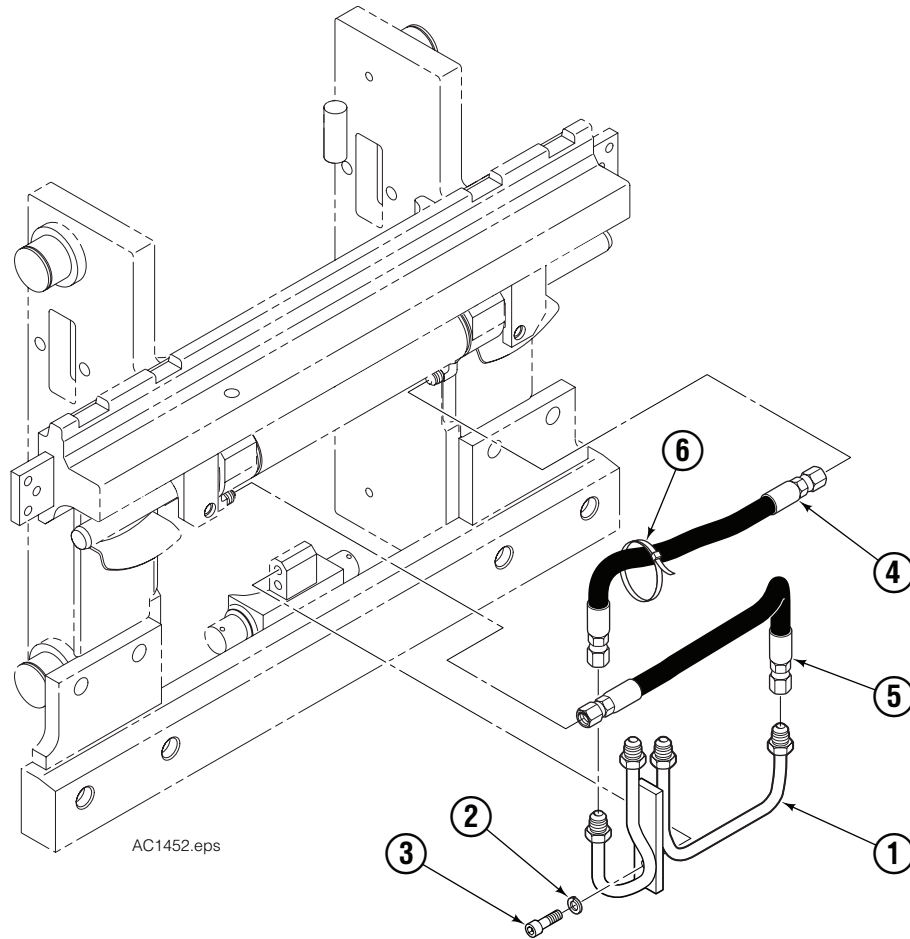

35K			
REF	QTY	PART NO.	DESCRIPTION
		6073277	Installation Kit
1	1	6074480	Tube Weldment
2	2	787384	Lockwasher, M8
3	2	768208	Capscrew, M8 x 25
4	1	6075420	Hose
5	1	6073276	Hose
6	2	200343	Cable Tie

Installation Kit Toyota

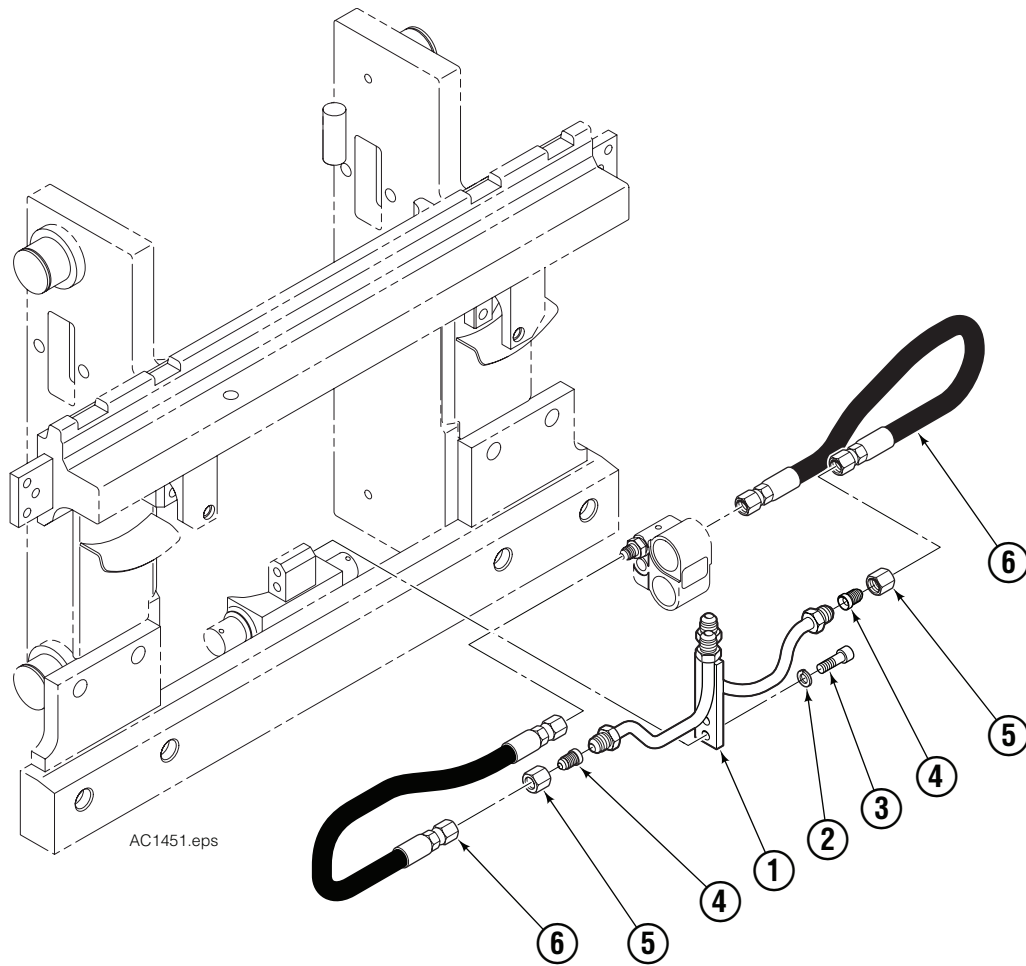

35K			
REF	QTY	PART NO.	DESCRIPTION
		6073430	Installation Kit
1	1	6074473	Tube Weldment
2	2	787384	Lockwasher, M8
3	2	768208	Capscrew, M8 x 25
4	2	2669	Fitting, 6-4
5	2	2617	Nut, 6
6	2	6050405	Hose

Do you have questions you need answered right now? Call your nearest Cascade Parts Department. Visit us online at www.cascorp.com

**Cascade Corporation
U.S. Headquarters**
2201 NE 201st
Fairview, OR 97024-9718
Tel: 800-CASCADE (227-2233)
FAX: 888-329-8207

Cascade Canada Inc.
5570 Timberlea Blvd.
Mississauga, Ontario
Canada L4W-4M6
Tel: 905-629-7777
FAX: 905-629-7785

Cascade GmbH
Niederwippekühl 1
58579 Schalksmühle
Germany
Tel: 02355-50900
FAX: 02355-509020

Cascade Finland
A. Petreliuksenkatu 3
01370 Vantaa
Finland
Tel: 09-8361925
FAX: 09-8361935

**Cascade N.V.
Benelux Sales and Service**
Damsluisweg 56
PO Box 3009
1300 El Almere
The Netherlands
Tel: 036-5492950
FAX: 036-5492974

Cascade (UK) Ltd.
Unit 4, 12 O'Clock Court
Attercliffe Road
Sheffield, S4 7WW
England
Tel: 0870-850-8756
FAX: 0870-850-8757

**Sales Scotland
Macade Systems Ltd.**
18 Melford Road
Righead Ind. Estate
Bellshill ML4 3LR
Scotland
Tel: 01698-845777
FAX: 01698-845888

Cascade (Africa) Pty. Ltd.
PO Box 625, Isando 1600
60A Steel Road
Sparton, Kempton Park
South Africa
Tel: 27-11-975-9240
FAX: 27-11-394-1147

Cascade Scandinavia AB
Hammarvägen 10
PO Box 124
S-56723 Vaggeryd
Sweden
Tel: 039-336950
FAX: 039-336959

**Cascade France
S.A.R.L. MHP**
1D Rue De Charaintru BP 18,
91360 Epinay-Sur-Orge
France
Tel: 01-6454-7500
FAX: 01-6454-7501

Cascade Hispania S.A.
Carrer 5, Sector C
Zona Franca Duanera
Poligono de la Zona Franca
08040 Barcelona, Spain
Tel: 93-264-07-30
FAX: 93-264-07-31

Cascade Italia S.R.L.
Via Dell'Artigianato 1
37050 Vago di Lavagno (VR)
Italy
Tel: 39-045-8989111
FAX: 39-045-8989160

Movimenta Lda.
Parque Industrial
Vale do Alecrim, Lote 108
2950-403 Palmela
Portugal
Tel: 351-212387340
FAX: 351-212387349

**Sales Switzerland
Fahrzeugbedarf**
8810, Horgen
Switzerland
Tel: 01-7279797
FAX: 01-7279798

Sales Poland
Targowa 35/61
03-728 Warszawa
Tel: 022-619 00 49
FAX: 022-619 00 49
Mobile Tel: 0501-27 29 55

Sales Russia
EMCG Material Handling
Equipment
Moscow
Tel: 095-795-2400
FAX: 095-795-2475
Email: emcg@emcg.ru

Cascade Japan Ltd.
5-5-41,
Torikai Kami
Settsu, Osaka
Japan, 566
Tel: 81-726-53-3490
FAX: 81-726-53-3497

Cascade Korea
121B 9L Namdong Ind.
Complex, 691-8 Gojan-Dong
Namdong-Ku
Inchon, 405-310 Korea
Tel: 82-32-821-2051
FAX: 82-32-821-2055

Cascade Australia
1445 Ipswich Road
Rocklea, QLD 4107
Australia
Tel: 1-800-227-223
FAX: 617-3373-7333

Cascade New Zealand
15 Ra Ora Drive
East Tamaki, Auckland
New Zealand
Tel: 64-9-273-9136
FAX: 64-9-273-9137

Cascade-Xiamen
No. 668 Yangguang Rd.
Xinyang Industrial Zone
Haicang, Xiamen City
Fujian Province
P.R. China 361026
Tel: 86-592-651-2500
FAX: 86-592-651-2571

**Sunstream Industries
Pte Ltd.**
No. 3 Tuas Link 1
2263
Singapore
Tel: 65-6863-3488
FAX: 65-6863-1368

**Cascade do Brasil
Distribuidora de Garras
e Garfos LTDA**
Av. General Valdomiro
de Lima 43
Jabaquara - Sao Paulo - S.P.
Brasil CEP 04344-070
Tel: 55-11-5016-2484
Fax: 55-11-5013-2809

